



PULSAFEEDER
A Unit of IDEX Corporation



Eclipse
The Power of
Design Innovation

Eclipse
Series



Reliable
Simple
Intuitive

Pulsafeeder Technology

Since 1936, Pulsafeeder has been recognized as a world leader in fluid handling and control technology. Pulsafeeder continues to deliver innovative solutions through a dedication to world-class design, application and systems integration expertise. The highest quality engineering precision and dependability is designed into each product manufactured by Pulsafeeder to maximize performance and ensure **global customer satisfaction**.

Eclipse Series Pumps

The Eclipse Series represents a dramatic advance in pump technology. Combining proven design principles with state of the art engineered composites, the Eclipse Series is the most reliable, simple and intuitive pump on the market today.

Industrial Construction

Eclipse Series pumps are built for use in the harshest industrial environments. Designed to be structurally rugged with corrosion-resistant materials, the Eclipse is an ideal fit for many medium to highly corrosive liquids used in the chemical processing, pulp and paper and water treatment industries.

Application Expertise

Pulsafeeder's vast experience in fluid handling provides the ultimate engineering expertise and application support to evaluate and customize process solutions.

Eclipse Series Product Scope

- Flows to 20gpm (4.5m3/hr)
- Pressures to 150psi (10 bar)
- Temperatures to 150°F (65°C)
- Viscosities to 10,000 CPS
- 2 feet NPSHR
- Pulsation-Free Flow
- Dry run capabilities

Materials of Construction

- Housings: Carbon-Reinforced ETFE
- Gears: Carbon-Reinforced PTFE
- Shafts: Alumina Ceramic
- Bearings: Pure Graphite or Graphite-Impregnated Silicon-Carbide

Typical Applications

- Acids
- Solvents
- Caustics
- Polymers
- Bleaches
- Dyes/Inks
- pH Control
- Catalysts
- Cleaning Agents
- And many more

Markets



Chemical



Food & Beverage



Pharmaceutical



Mining



Paints & Dyes



Petroleum



Petrochemical



Pulp & Paper



Power & Energy



Water Treatment



General Industries



Steel Industries

Eclipsing the Competition with New Levels of Reliability, Simplicity and Intuitiveness

The Eclipse Series is a line of innovational non-metallic industrial gear pumps designed for optimal performance and simplicity in operation and maintenance.

Corrosion Resistance:

- All wetted components are completely non-metallic.
- Pump housings and gears are made of Engineered Fluoropolymers with excellent corrosion resistance and strength over a broad range of chemicals and temperatures.
- No need for expensive high alloys prone to corrosion damage.



Sealless Design:

- Eclipse Series pumps are magnetically driven, meaning there is no mechanical seal with contacting seal faces that are prone to wear and leakage.
- Eliminates costly seal flush systems required for double mechanical seals.
- Zero leakage, no emissions of hazardous or regulated chemicals.
- A non-metallic containment can eliminate energy loss and heat rise due to Eddy Current losses common in metallic pumps.

Dry Run Capabilities:

- Capable of up to 30 minutes of dry-run conditions.
- Pump is protected from damage during system upset conditions such as a closed suction valve or empty supply tank.
- The patent pending bearing design promotes constant lubrication during periods of dry run.

% Temperature Rise During Dry Run

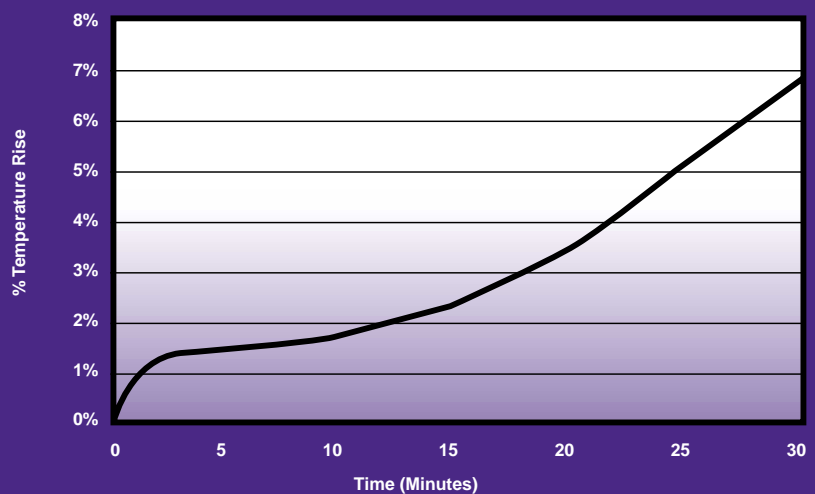



Design for Simplicity

- Total number of parts dramatically reduced.
- 16 total parts on the Eclipse Series vs. 40+ on typical metallic pumps.
- Fewer parts and material options means simplified ordering and inventory.
- Self-aligning parts and piloted fits ensure proper assembly every time.

Front-Pullout Design

- Replace all normal wear components without disturbing piping or motor connections.
- Pump can be serviced-in-place in a matter of minutes.
- Reduced down time means less maintenance costs, more production time.

Universal Flanges with PTFE Inserts

- Standard housings mate to both ANSI and DIN flange connections.
- PTFE inserts act as a gasket and can be reused or replaced to ensure a proper seal.

Renewable Performance

- Patent pending housing liner protects the housing from wear.
- Regain as-new performance with the change of a KOPkit.
- Keeps pump running at optimal performance and efficiency.

Heavy-Duty Bearings

- Large wear areas.
- Self lubricating materials and patent pending geometry allow dry-run capabilities.

Tolerance O-Ring

- Patent pending O-Ring maintains proper internal clearances, tolerant of axial part wear or thermal expansion.

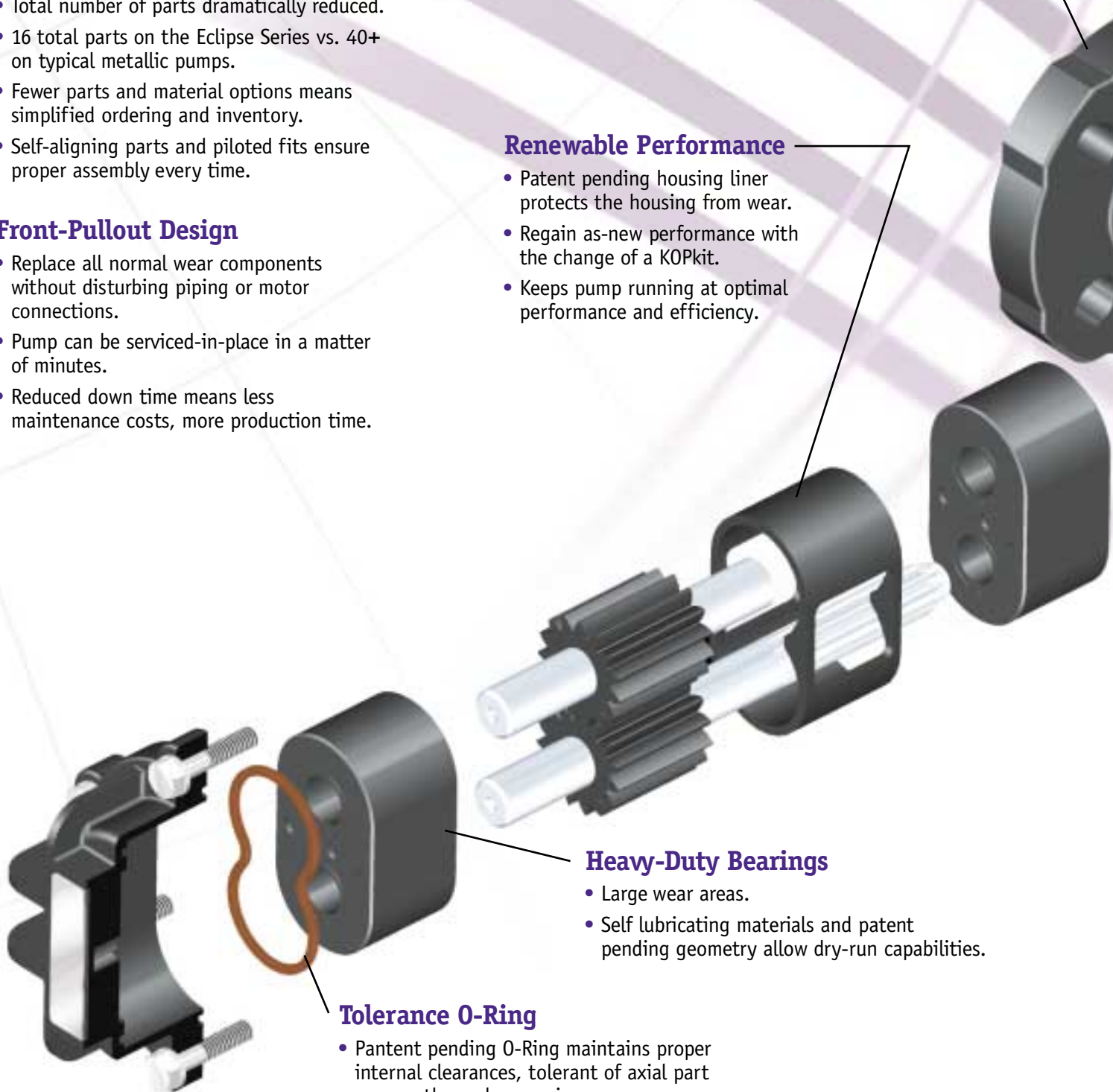

Universal Motor Adapter

- Standard adapters mate to multiple NEMA and IEC motors

Modular Magnet Hub

- One drive magnet per pump size, with interchangeable adapter-hubs to fit both standard NEMA and IEC motors

Fully Encapsulated Magnets

- Maximum corrosion resistance
- Patent pending spline design allows the magnet to “float” on shaft
- Magnet will self-align with no added fasteners
- No axial loads induced on the drive shaft

Close-Coupled Mounting

- Eliminates the cost and potential issues associated with pump and motor alignment.



KOPkits®

KOPkits are designed to guard against unnecessary down time and ensure the highest level of efficient and uninterrupted service. This kit includes the recommended spare parts to maintain as-new hydraulic performance.

Reliable
Simple
Intuitive



Eclipse 2 Fluid Viscosity: 1 cps 0.25 HP/KW Motor

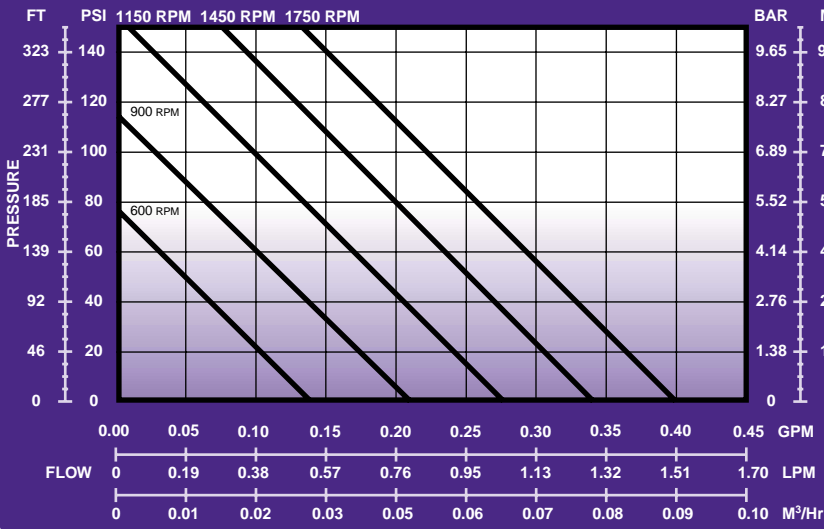

General Specifications

Port Size and Type	1/4" NPT or BSPT
Direction of Rotation	Bi-directional
Theoretical Displacement	0.02 gal / 100 rev. (0.76 cc / rev.)
Maximum Differential Pressure	150 psi (10 Bar)
Maximum Allowable Working Pressure	200 psi (14 Bar)
Maximum Speed	1750 rpm
Maximum Capacity at Opsig	0.4 gpm (1.5 LPM)
Maximum Viscosity	5,000 cps
Maximum Fluid Temperature	150°F (65°C)
Fluid pH Range	0-14
Gear Type	External Spur Gear
Bearing Type	Sleeve Bearing Integral Wear Plate
Motor Frame Sizes, NEMA	56C, 143/145TC
Motor Frame Sizes, IEC	63, 80 B14 Flange

Eclipse 2 Fluid Viscosity: 100 cps 0.25 HP/KW Motor

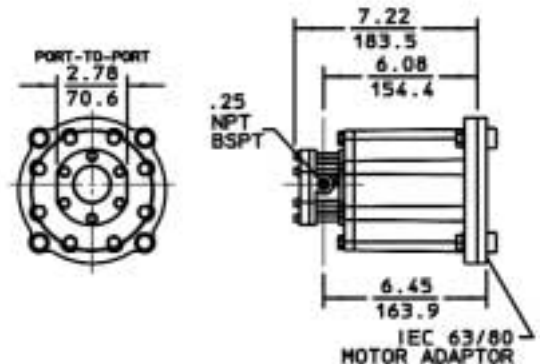
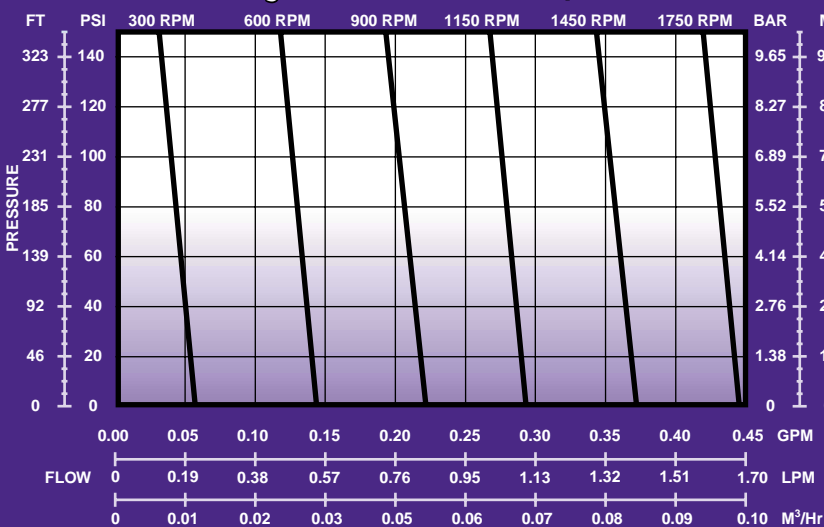

Eclipse Series 5



Eclipse 5 Fluid Viscosity: 1 cPS 0.50 HP/0.37KW Motor

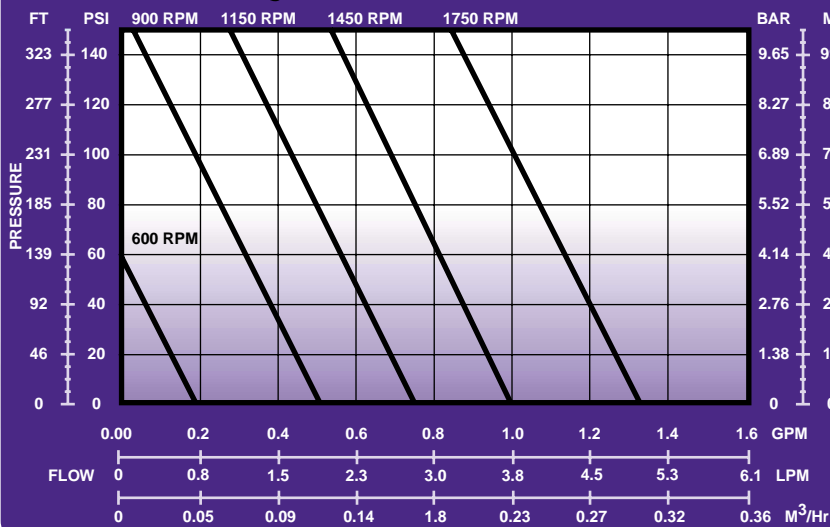

Eclipse 5 Fluid Viscosity: 100 cPS 0.50 HP/0.37KW Motor

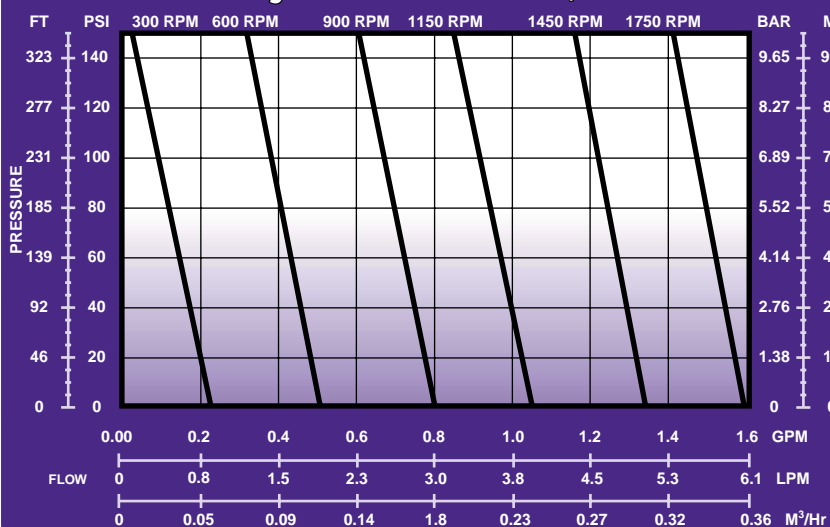

General Specifications

Port Size and Type	3/8" NPT or BSPT
Direction of Rotation	Bi-directional
Theoretical Displacement	0.07 gal / 100 rev. (2.8 cc / rev.)
Maximum Differential Pressure	150 psi (10 Bar)
Maximum Allowable Working Pressure	200 psi (14 Bar)
Maximum Speed	1750 rpm
Maximum Capacity at 0 psig	1.3 gpm (4.9 LPM)
Maximum Viscosity	10,000 cps
Maximum Fluid Temperature	150°F (65°C)
Fluid pH Range	0-14
Gear Type	External Spur Gear
Bearing Type	Sleeve Bearing Integral Wear Plate
Motor Frame Sizes, NEMA	56C, 143/145TC
Motor Frame Sizes, IEC	63, 80 B14 Flange

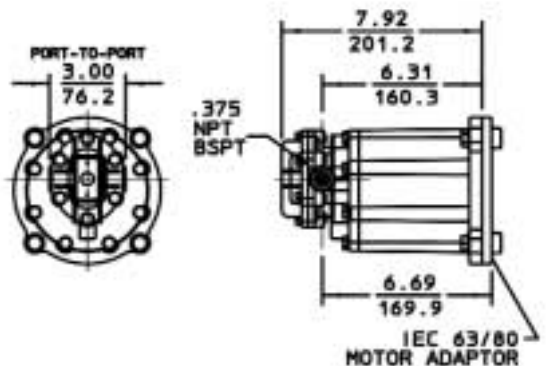

Eclipse Series 25



Eclipse 25 Fluid Viscosity: 1 CPS

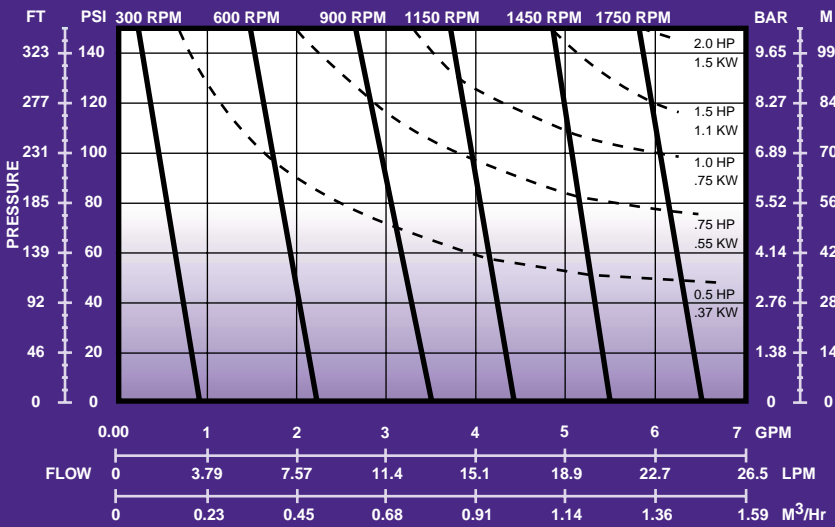

General Specifications

Port Size and Type	1" ANSI 150# / DIN 20/25 Flanged
Direction of Rotation	Bi-directional
Theoretical Displacement	0.37 gal / 100 rev. (14 cc / rev.)
Maximum Differential Pressure	150 psi (10 Bar)
Maximum Allowable Working Pressure	200 psi (14 Bar)
Maximum Speed	1750 rpm
Maximum Capacity at 0 psig	6.5 gpm (24.6 LPM)
Maximum Viscosity	10,000 cps
Maximum Fluid Temperature	150°F (65°C)
Fluid pH Range	0-14
Gear Type	External Spur Gear
Bearing Type	Sleeve Bearing Integral Wear Plate
Motor Frame Sizes, NEMA	143/145TC, 182/184TC
Motor Frame Sizes, IEC	100, 112 B14 Flange

Eclipse 25 Fluid Viscosity: 100 CPS

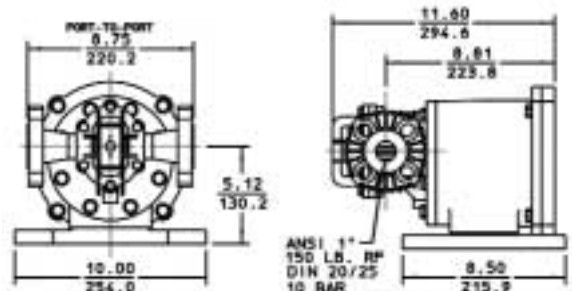
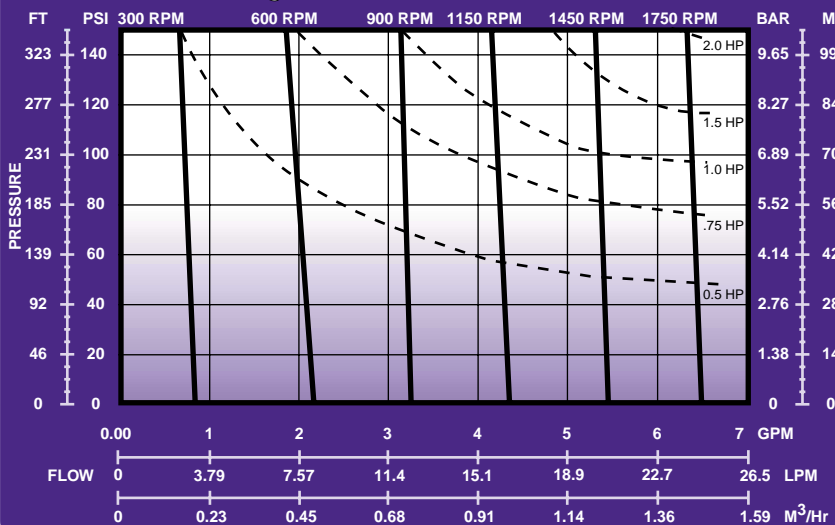

Eclipse Series 75



Eclipse 75 Fluid Viscosity: 1 cPS

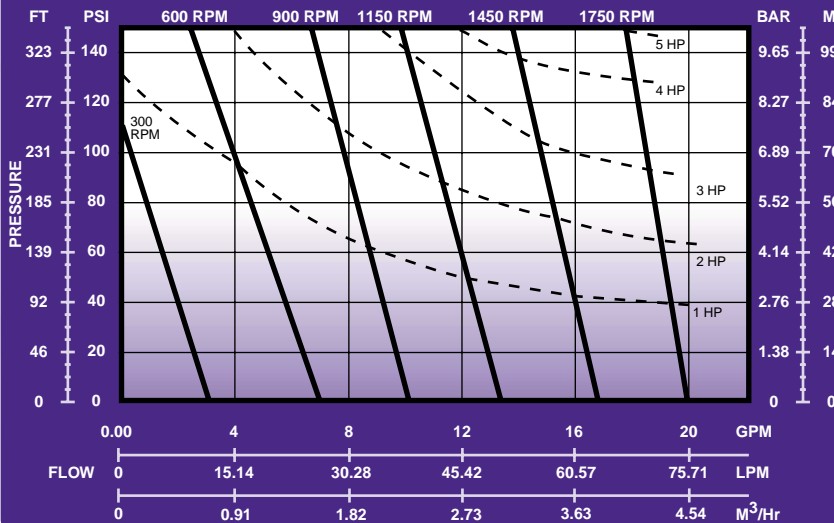

Eclipse 75 Fluid Viscosity: 100 cPS

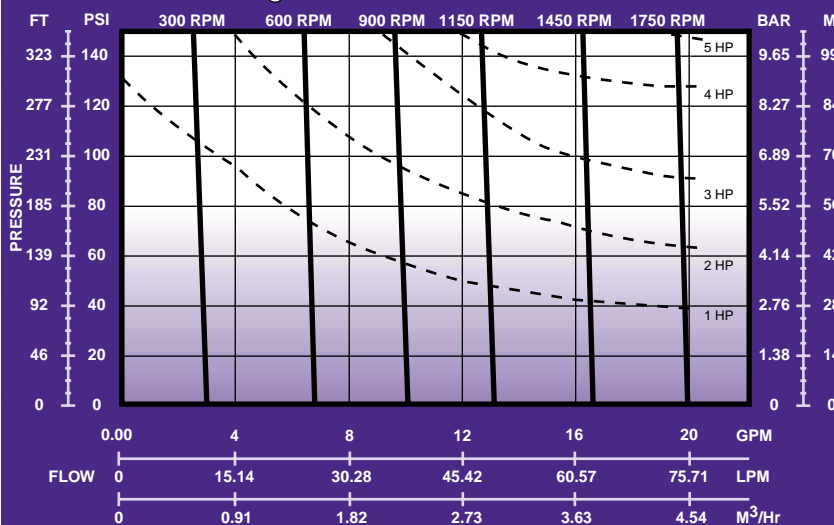

General Specifications

Port Size and Type	1.5" ANSI 150# / DIN 30/40 Flanged
Direction of Rotation	Bi-directional
Theoretical Displacement	1.14 gal / 100 rev. (43.2 cc / rev.)
Maximum Differential Pressure	150 psi (10 Bar)
Maximum Allowable Working Pressure	200 psi (14 Bar)
Maximum Speed	1750 rpm
Maximum Capacity at 0 psig	20 gpm (75 LPM)
Maximum Viscosity	10,000 cps
Maximum Fluid Temperature	150°F (65°C)
Fluid pH Range	0-14
Gear Type	External Spur Gear
Bearing Type	Sleeve Bearing Integral Wear Plate
Motor Frame Sizes, NEMA	143/145TC, 182/184TC
Motor Frame Sizes, IEC	100, 112 B14 Flange

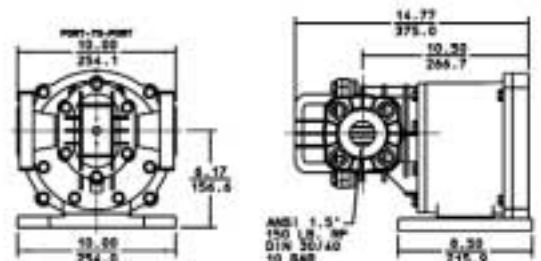



Pressure Relief Valves

Pressure relief valves (PRV) are used to protect the pumping system from over-pressurization damage as the result of a closed or blocked discharge line.



Engineered Systems

Pulsafeeder offers combined process control and mechanical expertise through our chemical injection and delivery systems capabilities.



Shaft Power Monitors

Power monitors utilize the motor as a sensor to protect the pump during upset conditions like dry-run, cavitation or jamming.

Reliable
Simple
Intuitive

Eclipse Model Number String

Model Position 1	E	---	---	---	---	---	---	---
Size Position 2,3	02, 05, 25, 75							
Base Material Position 4	E-ETFE, FNPT, B-ETFE, BSPT, F-ETFE, Flange, P-PPL, Flange							
Bearings Position 5	L-Carbon, B-Silicon-Carbide							
O-Rings Position 6	V-Viton, E-EPDM, K-Kalrez							
Mounting Arrangements Position 7	F-NEMA 56C, O-NEMA 143TC-182C, R-NEMA 182TC-184TC H-IEC B14 63, K-IEC B14 80, P-IEC B14 100/112							
Options Positions 8, 9	A-Bearing Flush Ports, Y-With Drive Magnet, N-Without Drive Magnet, X-No Options							

To contact the nearest Pulsafeeder Global Sales Office, visit us on the web at www.pulsa.com



Pulsafeeder, Inc.
Engineered Pump Operations
2883 Brighton-Henrietta Townline Road
Rochester, New York 14623 U.S.A.
585-292-8000 Telefax 585-424-5619

